

Lin

Buffet 2 portas



TOK&STOK
www.tokstok.com.br

Bem-vindo

A Tok&Stok traz até você soluções práticas de design com manuais de montagem e instalação detalhados para possibilitar o pleno aproveitamento do potencial dos produtos.

Para assegurar a garantia, é recomendada a prévia conferência de partes e componentes, bem como a leitura dos passos e suas ilustrações.

Preservar este documento é essencial para a adequada manutenção de seu móvel, o que engloba os possíveis ciclos de montagem e desmontagem.

Central de atendimento: 0800 200 8000

Horário de atendimento: segunda à sábado das 8h às 18h.

Recomendações

Para a montagem deste produto, são necessárias 2 pessoas.

Evitar batidas e o contato com objetos cortantes.

Observar as cargas máximas suportáveis, quando houver, conforme o desenho esquemático no final do documento.

Partes do produto protegidas da incidência de luz estão sujeitas a alterações de tonalidade diferentemente das expostas. Somente o uso freqüente pode amenizar esta ocorrência.

Algumas pinturas novas, embora atóxicas, podem apresentar odores. Para amenizá-los, mantenha o móvel em local arejado por aproximadamente três dias.

Manutenção

Pano levemente umedecido com água, seguido de pano seco.

*Nunca utilize produtos químicos ou abrasivos.

Abaixo sinalizadas, as ferramentas não fornecidas mas necessárias para a montagem do produto.

 Martelo Borracha	 Martelo	 Chave Phillips	 Chave Fenda	 Chave Phillips Pequena	 Chave Fenda Pequena
 Furadeira com Broca de 8mm	 Parafusadeira ponta Phillips	 Trena	 Nível	 Escada	 Esquadro

Partes do Produto

1 Tampo (1x)

2 Base (1x)

3 Lateral (2x)

4 Porta Direita (1x)

5 Porta Esquerda (1x)

6 Fundo (1x)

7 Prateleira (1x)

8 Travessa (2x)

9 Pé (4x)

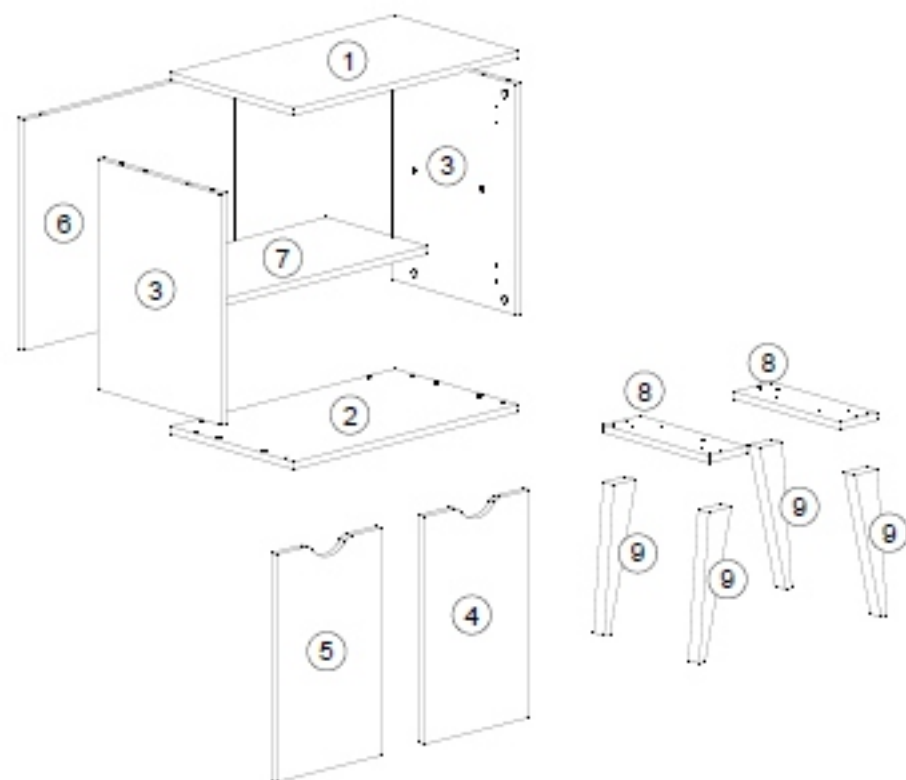

Componentes



A- Cavilha 8x30 (12x)

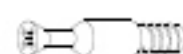

B- Minifix (8x)



C- Tambor (8x)



D- Tapa Furo
Adesivo (8x)



E- Dobradiça (4x)



F- Calço (4x)



G- Parafuso Ø4x16 (16x)



H- Parafuso Ø4x25 (8x)



I- Parafuso Ø4x40 (8x)



J- Suporte Prateleira (6x)

Utilizar a régua abaixo para medir os componentes.

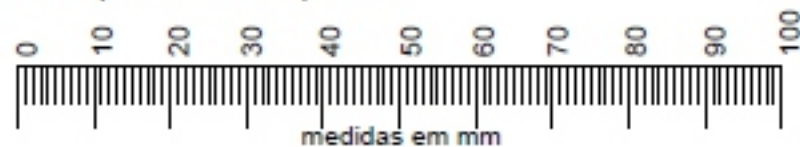

Pré-Montagem

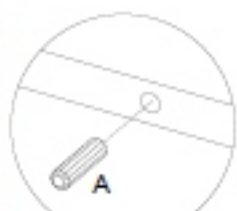
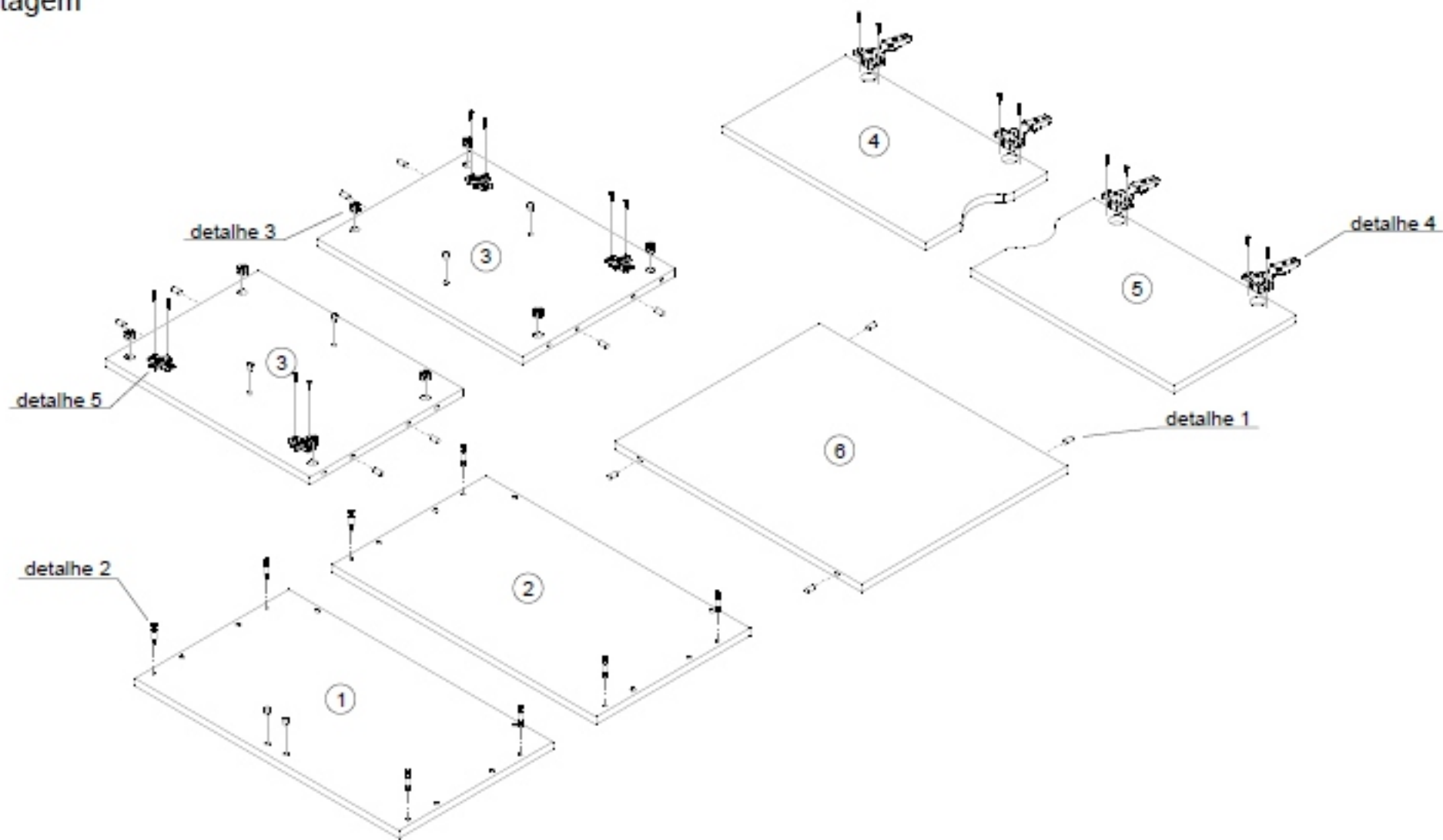

detalhe 1

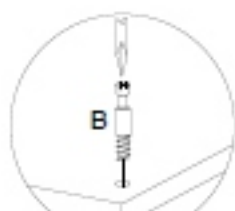

detalhe 2



detalhe 3

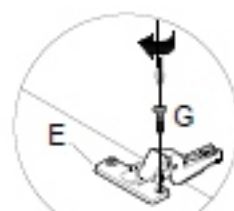

detalhe 4

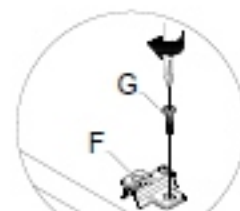

detalhe 5

