

Morpheus

Cabeceira Solteiro

Cabeceira Casal

Cabeceira Queen

Cabeceira King

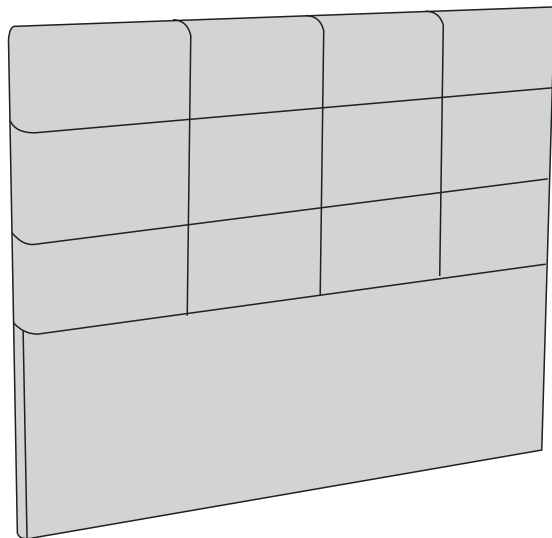

Ferramentas necessárias (não fornecidas)

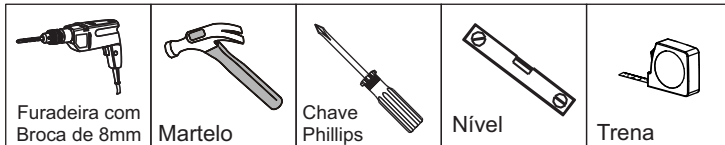

Limpeza:

Aspirador de pó ou escova com cerdas macias.

Cuidados:

Não utilizar produtos químicos, abrasivos ou limpeza a vapor.
Evitar contato com objetos cortantes.

Partes do Produto

- 1 Encosto (1x)
- 2 Suporte da parede (2x)

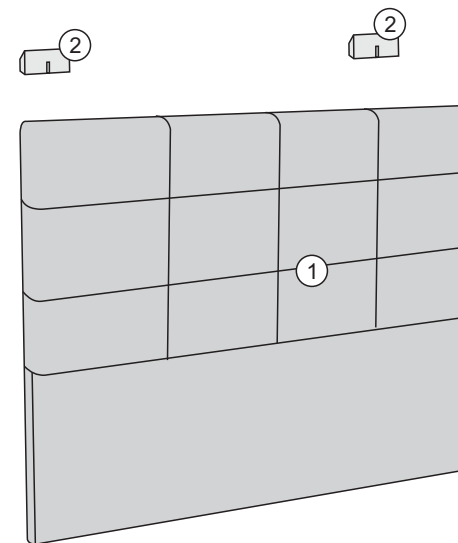

Componentes



A- Parafuso
5X70 c.f. (2x)



B- Bucha 8mm (2x)



C- Sapata (2x)



D- Parafuso
3,5x30 c.p. (2x)



E- Arruela (2x)

1 Fixação na Parede

- 1) Fazer as marcações na parede utilizando a furação do suporte (2) como base. Observar o correto nivelamento (nível não fornecido), prevendo o espaço necessário para a fixação do produto.
- 2) Furar a parede com uma furadeira+broca 8mm (não fornecida).
- 3) Encaixar as Buchas (B) nos furos e fixar o suporte (2) com os Parafusos (A) com o auxílio de uma chave phillips (não fornecida).

A empresa não se responsabilizará por acidentes decorrentes da não observância dos passos acima e nem pela fragilidade da parede.

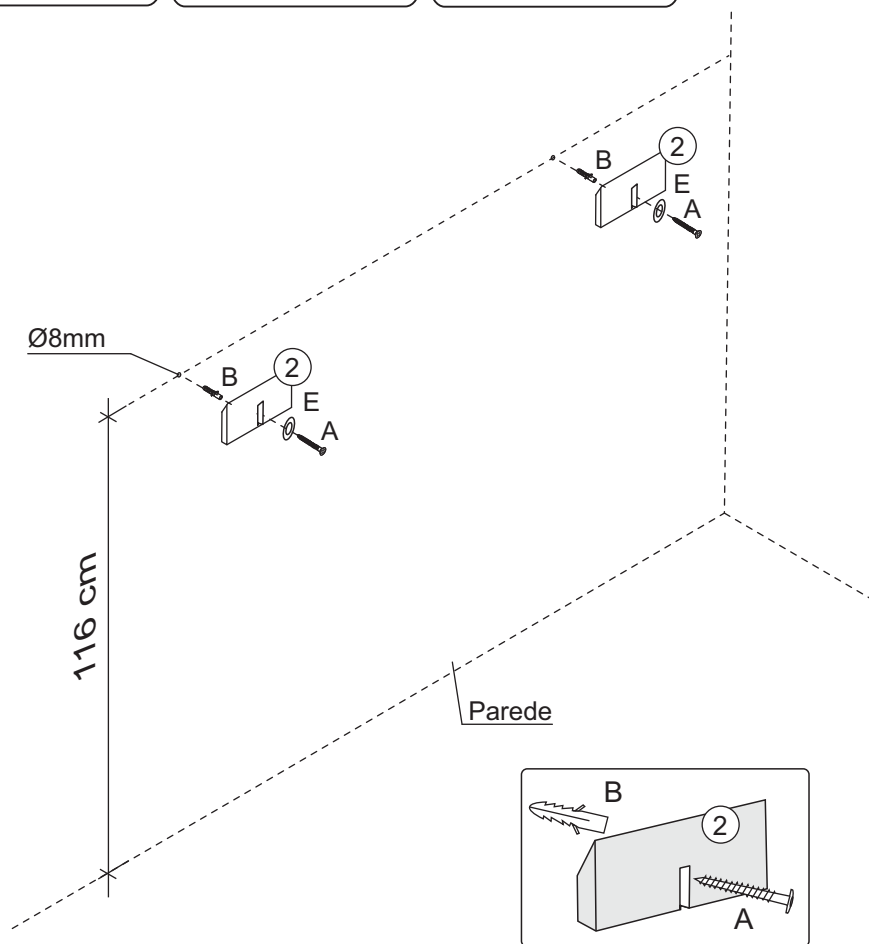
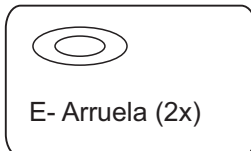
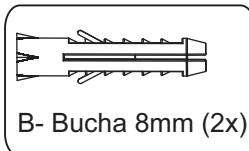
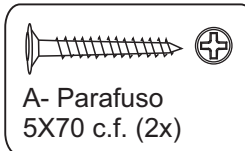

2

