

notória

poltrona giratória

TOK&STOK

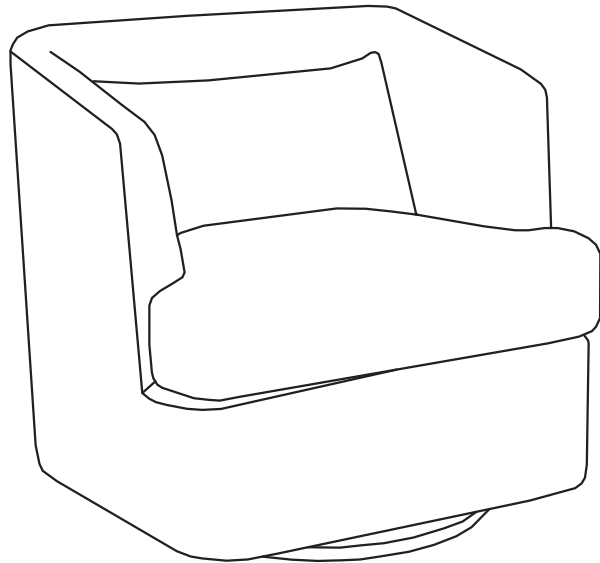

partes do produto

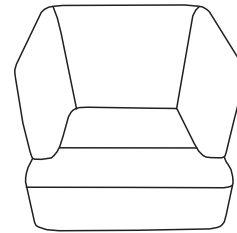

1 Encosto (1x)

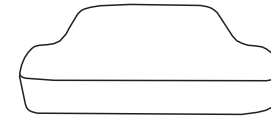

2 Assento (1x)

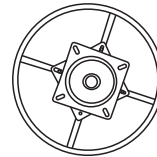

3 Base (1x)

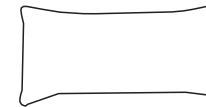

4 Almofada encosto (1x)

componentes

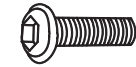

A- Parafuso M6x20 (4x)



B- Arruela (4x)



C- Chave allen (1x)



1
pessoas necessárias
para montar
o produto



fácil

grau de
dificuldade



Não utilizar produtos
químicos ou abrasivos na
limpeza.



Evitar batidas e o
contato com objetos
cortantes.



Tecido: aspirador de pó ou
escova com cerdas
macias. Metal: pano
levemente umedecido com
água, seguido de pano
seco.



120
Kg
capacidade máxima
suportável, distribuída
uniformemente

1

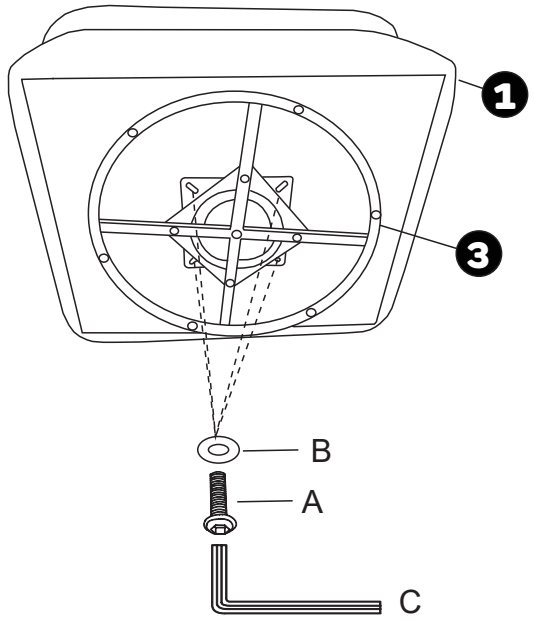

2

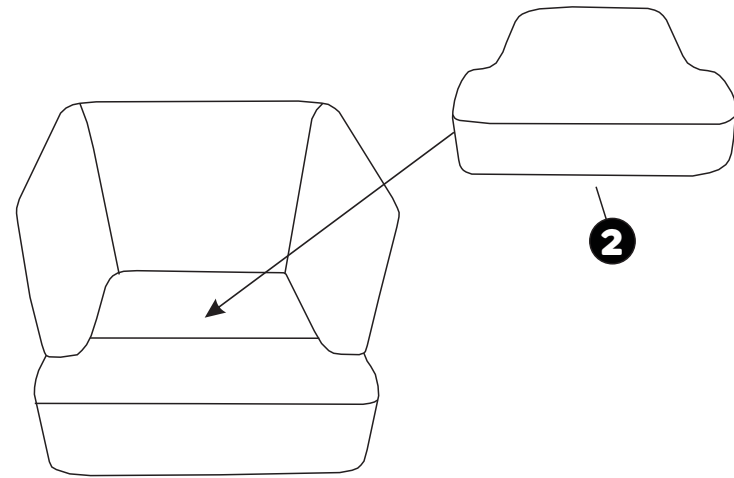

3

